



# Specification

## 规格书

**Customer:**

客户名称: \_\_\_\_\_

**MASON P/N:**

恒润产品型号: \_\_\_\_\_

MS-S4014NW3AX2SF-A05-90MAV

**Customer P/N:**

客户产品型号: \_\_\_\_\_

**Customer Approved Production Parameter BIN**

客户承认产品BIN表

<b>IV/LM:</b> 亮度/流明:	<b>WL/XY:</b> 波长/区块:	<b>CCT:</b> 色温:
<b>VF:</b> 电压:	<b>Ra:</b> 显指:	<b>Other:</b> 其它:
<b>Approved By</b> 审核		<b>Checked By</b> 确认

**MASON SMD R & D Department**

恒润SMD研发部

<b>Approval</b> 核准	<b>Check</b> 审核	<b>Design</b> 设计



Preliminary SPEC 初步规格书

Part NO:MS-S4014NW3AX2SF-A05-90MAV

**Features 特性**

- Dimensions:4.0x1.4x0.53mm. 封装尺寸:4.0x1.4x0.53mm
- Wide viewing angle. 广视角
- Package : 4000pcs / reel. 包装:每卷4000pcs
- ROHS Compliant. ROHS认证

**Applications 应用**

- LED TV backlight 电视背光
- General lighting 一般照明



**ATTENTION**  
 OBSERVE PRECAUTIONS  
 FOR HANDLING  
 ELECTROSTATIC  
 DISCHARGE  
 SENSITIVE  
 DEVICES  
 注意: 接触静电放电敏感元  
 件时请采取适当的预防措施



◆ **Package Dimensions 封装尺寸**

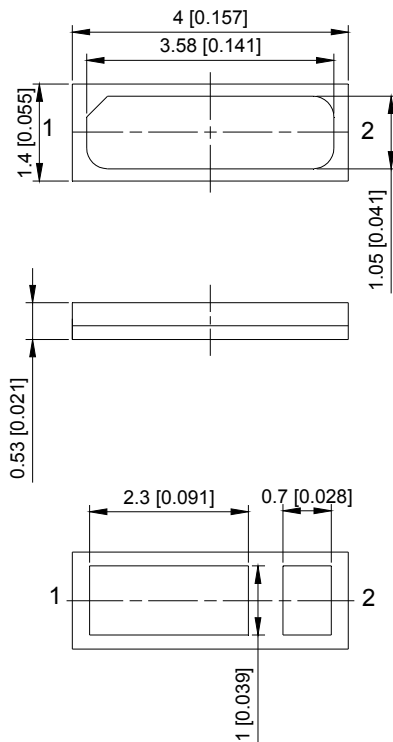

◆ **Recommended soldering pattern 建议焊盘尺寸图**

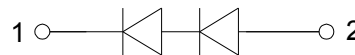
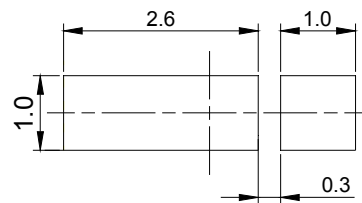

Notes:

1. All dimensions are in millimeters.以上单位均为mm。
2. Tolerance is  $\pm 0.25$ mm unless otherwise noted.以上公差范围非特别注释均为 $\pm 0.25$ mm
3. Specifications are subject to change without notice.规格如有变更,恕不另行通知。



◆ **Device Selection Guide 元件选择指南**

Part No. 型号	Chip Material 晶片材质	Emitting color 发光颜色
MS-S4014NW3AX2SF-A05-90MAV	(InGaN)	WHITE

◆ **Absolute Maximum Ratings at TA=25°C 绝对最大额定参数TA=25°C**

Parameter 参数	Symbol 符号	Rating 值	Unit 单位
Power Dissipation 功耗	PD	900	mW
Forward Current 正向电流	IF	150	mA
Peak Forward Current*1 正向峰值电流	IFP	200	mA
LED Junction Temperature 结温	Tj	115	°C
Thermal Resistance 热阻	Rthj-s	35	°C/W
Reverse Voltage 反向电压	VR	5	V
Operating Temperature 工作温度	Topr	-40°C To +85°C	
Storage Temperature 储存温度	Tstg	-40°C To +85°C	

Notes: \*1: Pulse width≤0.1ms, Duty cycles≤1/10  
备注\*1: 脉冲宽度≤0.1ms, 占空比≤1/10

◆ **Optical / Electrical Characteristics at TA=25°C 光电特性TA=25°C**

Parameter 参数	Symbol 符号	Min. 最小值	Typ. 平均值	Max 最大值	Unit 单位	Test Conditions 测试条件
Forward Voltage (one circuit) 正向电压	VF	5.4		6.4	V	IF=90mA
Reverse Current (one circuit) 反向电流	IR	—	—	10	μA	VR=10V
Luminous Flux 光通量	Φ	66	—	74	LM	IF=90mA
Viewing Angle 发光角度	2θ1/2	—	120	—	Deg.	

Remarks:备注

If special sorting is required (e.g. binning based on forward voltage, luminous intensity or chromaticity), the typical accuracy of the sorting process is as follows:

如果有特殊的分档需要（例如基于正向电压、流明强度或色度坐标的分类），则其分档的典型精确度如下所示

1. Chromaticity Coordinates: ±0.005 色度坐标: ±0.005
2. Luminous Intensity: ±10% 流明强度: ±10%
3. Forward Voltage: ±0.1V 正向电压: ±0.1V



◆ Typical Electrical/Optical Characteristics Curves 典型光电特性曲线

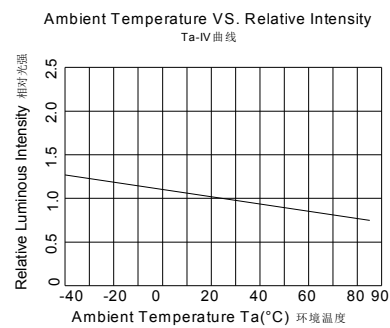
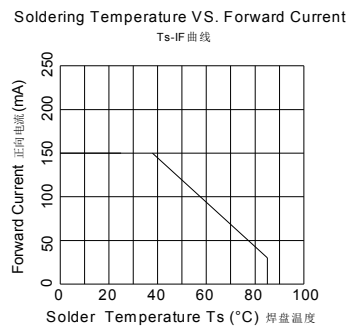
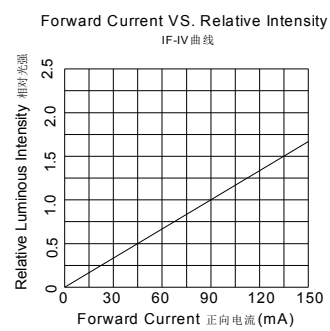
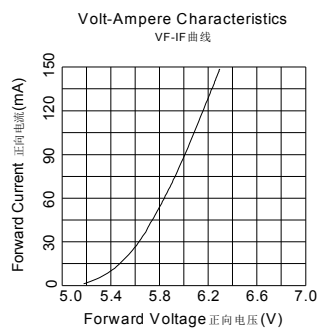
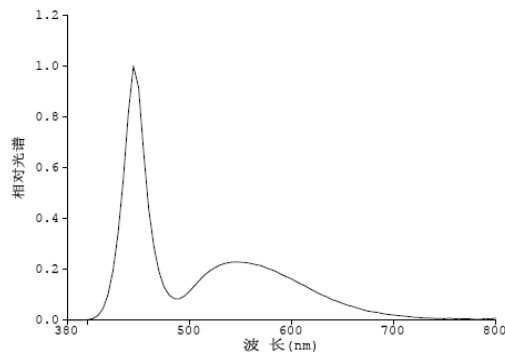

Radiation Diagram  
辐射特性曲线

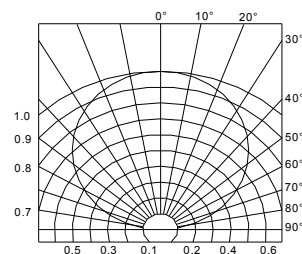



◆ VF Rank 电压等级

Rank 等级	VF(V) 电压		Test Conditions 测试条件
	Min 最小值	Max 最大值	
V	5.4	5.6	IF=90mA
W	5.6	5.8	
X	5.8	6.0	
Y	6.0	6.2	
TA	6.2	6.4	

Tolerance:±0.1V 公差: ±0.1V

◆ ΦV Rank 亮度等级

Rank 等级	Φ(lm) 亮度		Test Conditions 测试条件
	Min 最小值	Max 最大值	
M66	66	68	IF=90mA
M68	68	70	
M70	70	72	
M72	72	74	

Tolerance:±10% 公差: ±10%

◆ λd Rank 波长等级

Rank 等级	HUE (nm) 波长	
	Min 最小值	Max 最大值
W42	442.5	445.0
W45	445.0	447.5
W47	447.5	450.0
W50	450.0	452.5
W52	452.5	455.0



◆ X/Y Rank 色度坐标等级

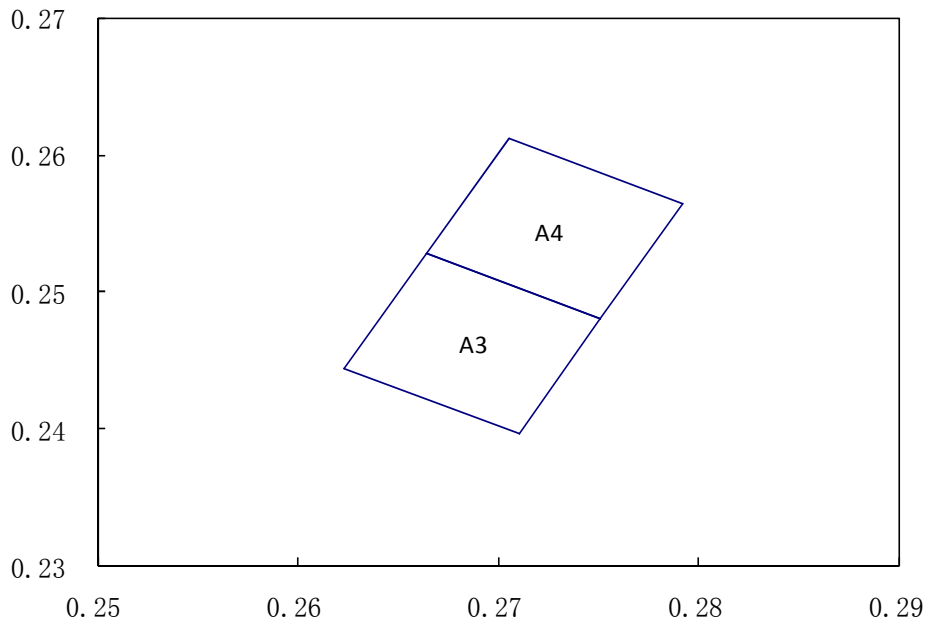

A3	X	0.2664	0.2751	0.2710	0.2623
	Y	0.2528	0.2480	0.2396	0.2444
A4	X	0.2705	0.2792	0.2751	0.2664
	Y	0.2612	0.2564	0.2480	0.2528

Tolerance:  $\pm 0.005$  公差:  $\pm 0.005$



◆ **Reliability Test Items and Conditions** 信赖性测试项目及条件

Test Item 实验项目	Reference 参考标准	Test Conditions 实验条件	Time 时间	Quantity 数量	Criterion 判定
Thermal Shock 冷热冲击	JIS-C7021 A-4	100°C±5°C 15min ↓ -40°C±5°C 15min	200cycles 循环200次	22	0/22
High Temperature Storage 高温储存	JEITA ED- 4701 200 201	Ta=100°C	1000h 1000小时	22	0/22
Low Temperature Storage 低温储存	JEITA ED- 4701 200 202	Ta=-40°C	1000h 1000小时	22	0/22
High Temperature High Humidity Storage 高温高湿储存	JIS-C7021 B-11	Ta=85°C, RH=85%	1000h 1000小时	22	0/22
Resistance to Soldering Heat 耐焊接热	GB/T 4937	Tsol*=(260±5)°C 10secs.	2times 2次	22	0/22
Life Test 常温寿命试验	JESD22-A108	Ta=25°C ±5°C IF=90mA	1000h 1000小时	22	0/22
High Temperature Life Test 高温寿命试验	JESD22-A108	Ts=-55°C ±5°C IF=90mA	1000h 1000小时	22	0/22

Note: T<sub>sol</sub>-Temperature of tin liquid. 备注: T<sub>sol</sub>-锡液温度

◆ **Criteria for Judging the Damage** 失效判断标准

Item 项目	Symbol 符号	Test Condition 测试条件	Failure Criteria 判定标准	
			MIN.最小	MAX.最大
Forward Voltage 正向电压	VF (V)	IF=90mA	---	U.S.L*1.1
Reverse Current 反向电压	IR (uA)	VR=10V	---	10uA
Luminous Flux 光通量	Φ (LM)	IF=90mA	L.S.L*0.7	---

Note: 1. U.S.L: Upper Specification Level 规格上限  
 2. L.S.L: Lower Specification Level 规格下限



◆ **Tape specifications (Units:mm) 载带规格 (单位: mm)**

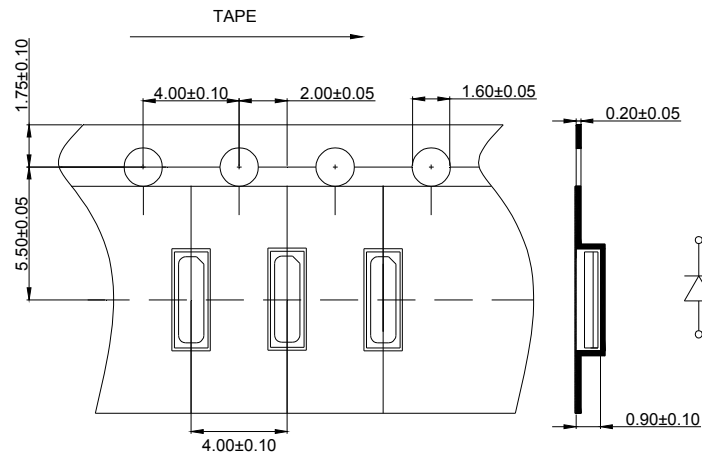

◆ **Moisture Resistant Packaging 防潮袋包装**

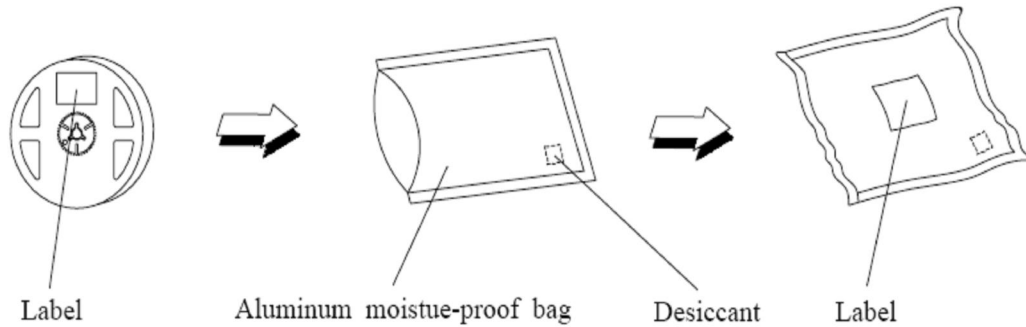

◆ **Label Explanation 标签说明**

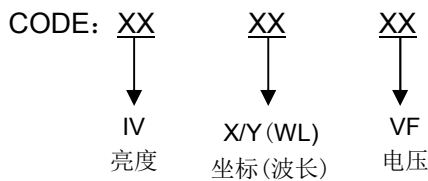

	广东恒润光电有限公司	
	Guangdong Mason Technologies Co., Ltd	
Part NO.:		
QTY:	PCS	CODE:
Lot NO:		
ERP NO.:		
Date:		

◆ **Hand Soldering 人工焊接**

A soldering iron of less than 20W is recommended to be used in Hand Soldering, Please keep the temperature of the soldering iron under 360°C while soldering. Each terminal of the LED is to go for less than 3 second and for one time only

Be careful because the damage of the product is often started at the time of the hand soldering.

推荐使用功率低于20W的烙铁，焊接时烙铁的温度必须保持在360°C以下，且每个电极只能进行一次焊接，每次焊接的持续时间不得超过3秒。

人工焊接过程中的不慎操作易引起LED产品的损坏，应当小心谨慎。





◆ Soldering Profile 回流焊接

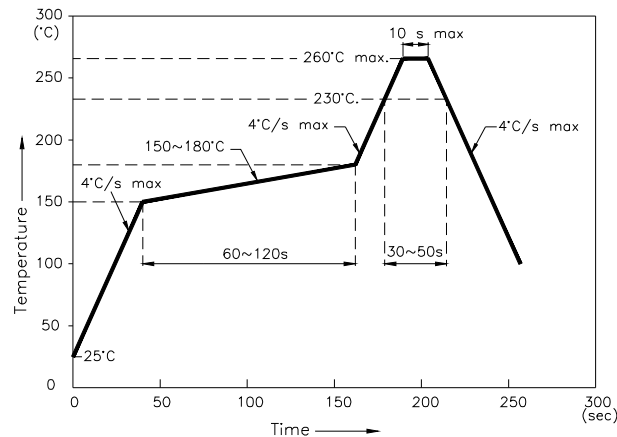

- We recommend the reflow temperature 245°C (±5°C). The maximum soldering temperature should be limited to 260°C.
- Reflow soldering should not be done more than two times, the interval should be controlled within 12 hours between the 1st and 2nd reflow process.
- Stress on the LEDs should be avoided during heating in soldering process.
- After soldering, do not deal with the product before its temperature drop down to room temperature.
- 建议的回流焊温度245°C (±5°C)。最大的焊接温度需限制在260°C。
- 回流焊接最多不宜超过两次，两次回流焊之间的时间间隔应控制在12小时以内。
- 在回流焊接升温过程中，请不要对LED施加任何压力。
- 在焊接完成后，待产品温度下降到室温之后，再进行其他处理。

◆ Cautions 注意事项

1.ESD ( Electrostatic Discharge)

静电

Static Electricity or power surge will damage the LED.

The following procedures may decrease the possibility of ESD damage.

- All production machinery and test instruments must be electrically grounded.
- Use a conductive wrist band or anti-electrostatic glove when handling these LEDs.
- Use anti-static packaging for transport and storage.

静电和电涌会对LED造成损毁。

下列方式有减少静电危害的可能性。

- 所有生产机械和测试设备必须接地。
- 操作LED灯时，需佩戴防静电手环或防静电手套。
- 运输和储存需用防静电袋包装。

2.Cleaning

清洗

- LED should be cleaned in a normal temperature and the time for cleaning should be less than 3 minutes ; please use Alcohol as cleaner ,before you use other cleaning solvent . Please make sure that the cleaner will not make any damage to the LED performance or the appearance .
- Ultrasonic Cleaning is also commonly used for cleaning LED , please verify the Ultrasonic cleaning 's Power and time to avoid any damages to the LED .
- The recommended solvent for cleaning:
- LED的清洗推荐在常温下进行且清洗时间不超过3分钟，建议优先选用酒精做为清洗剂，在选用其他溶剂清洗前请先确认不会对LED封装性能或外观造成损伤。
- 超声波清洗也是常用的有效方法，在进行大批量清洗前请先验证超声波清洗的功率及时间是否会对LED造成损伤。
- 推荐的溶剂:

Address: B building, west 2nd road Songshanhu high technology industry zone, Dongguan city, Guangdong, China

地址: 东莞市松山湖高新技术产业开发区工业西二路B区

TEL: +86-769-33335828

http://www.Mason-led.com



Common cleaning solvent 常规清洁溶剂	Disable cleaning solvent 禁用清洁溶剂
Alcohol 酒精	Thinner、Acetone、Two fluorine resin 、 Acetone b dilute 稀释剂、丙酮、 二氟脂、三氯乙稀

### 3.Sulfuration

#### 硫化

The sulfuration of LED is caused by elemental sulfur in air, which might diffused into LED and react with the silver layer in some conditions. It may produce  $Ag_2S$ , a kinds of black substance, which leads LED appearing black inside.

Failure phenomenon: High light failure and chrome coordinate drift.

Precautionary measures: Select and use quality guaranteed PCB board ,solder substance and other related material. Avoid exposure to elemental sulfur substance. Never store LED with high oxidizing or reducing substances or other corrosive material. All the LED products can't be lighting in strong acid and strong alkali environment without special processing.

LED的硫化现象的产生：在一定条件下环境中的硫元素会渗透进入LED支架内部，与支架镀银层发生化学反应生成黑色物质 $Ag_2S$

失效现象：光衰大，色温色坐标漂移

预防措施：选用有质量保证的PCB板材、焊料及其他配套辅料；避免暴露在富含硫元素的环境中；避免与强氧化、还原性物质或其他腐蚀性物质存放于同一环境中；若未经特殊工艺处理，所有LED产品应避免在强酸、强碱环境下点亮

The sulfide bad picture硫化后的不良图示:

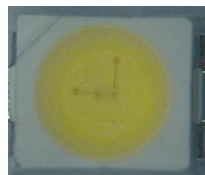

Normal material  
正常材料

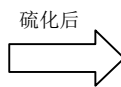

Sulfide materials, stent Bowl Cup silver layer black  
硫化后支架碗杯银层变黑

### 4.Storage

#### 储存

- Storage condition before opening the package:  $5^{\circ}C \sim 30^{\circ}C$ , the largest percentage relative humidity is 60% and the storage period is one month. The LEDs beyond the storage period just can be used after dealing as step 4.
- After opening the package, If the LEDs will be Infrared reflow soldering, Oxygen phase reflow soldering or any other welding.
  - a. must be welding within 24 hours.
  - b. the storage humidity must be below 30% .
- If the situation does not satisfy 2a or 2b, the LEDs must be roasted.
- 4 If the LEDs need to be roasted, the roast temperature should be  $60^{\circ}C \pm 3^{\circ}C$  and the roast time should be 48hours.
- 未拆封前的储存条件： $5^{\circ}C \sim 30^{\circ}C$ ，最大相对湿度60%，储存时间1个月，超过1个月的LED按步骤4处理后才能正常使用。
- 袋子开封后，元件若将进行红外线回焊、氧相回焊或类似的焊接处理，必须在
  - a. 24小时内完成焊接工作。
  - b. 储存湿度低于30% 。
- 假如不符合2a或2b的条件，则元件必须烘烤。
- 若元件须烘烤，烘烤条件为： $60^{\circ}C \pm 3^{\circ}C$ ，48小时。



## 5.Design Consideration

### 设计建议

In designing a circuit, the current through each LED must not exceed the absolute maximum rating specified for each LED. In the meanwhile, resistors for protection should be applied, otherwise slight voltage shift will cause big current change, burn out may happen. Directional constant current sources are suggested to be the driving for each LED.

It is recommended to use Circuit A which regulates the current flowing through each LED rather than Circuit B. When driving LEDs with a constant voltage in Circuit B, the current the LEDs may vary due to the variation in Forward Voltage (VF) of the LEDs. In the worst case, some LED may be subjected to stresses in excess of the Absolute Maximum Rating.

设计电路时，通过LED的电流不能超过规定的最大值，同时，还需使用保护电阻，否则，微小的电压变化将会引起较大的电流变化，可能导致产品损毁。建议对各LED分别使用恒流驱动。

建议使用以下A电路，该电路能够很好的调节通过每个LED的电流；不推荐使用B电路，该电路在持续的电压驱动下，LED的正向电压(VF)发生变化，电流会随之而发生变化，可能使某些LED承受高于规定的电流值。

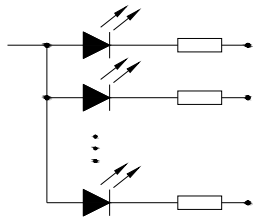

Recommended to use Circuit A  
 建议使用电路A

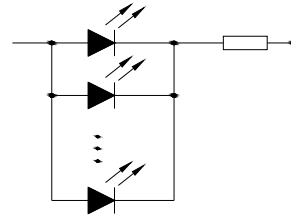

Not recommended to use Circuit B  
 不建议使用电路B

## 6.Operating

### 操作

• Do not directly touch or Handle the silicone lens surface, when handling the product, touching the encapsulant, with bare hands will not only contaminate its surface, but also affect on its optical characteristic. Excessive force to the encapsulant might result in catastrophic failure of the LEDs due to die breakage or wire deformation. For this reason, LED produces can't suffer excessive pressure or strong crash down caused by high-altitude falling.

• 不可直接用手或尖锐金属压胶体表面，直接用手拿取产品不但会污染封装树脂表面，也可能由于静电等因素导致产品性能的改变。过度的压力也可能直接影响封装内部的管芯和金线，因此请勿对产品施加过度压力或使其高空跌落。

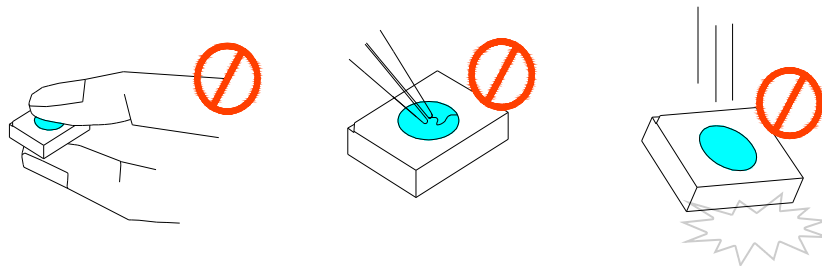

- Handle the component along the side surfaces by using forceps or appropriate tools.
- 用镊子或合适的工具夹在元件的侧边

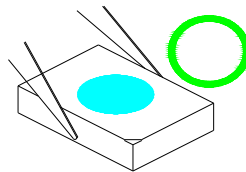



- Do not stack together assembled PCBs containing exposed LEDs. Impact may scratch the silicone lens or damage the internal circuitry.
- 若PCB上已贴装了LED且暴露在外，请勿将PCB叠成堆。相互间的挤压可能会划伤硅胶透镜表面或损坏内部电路。

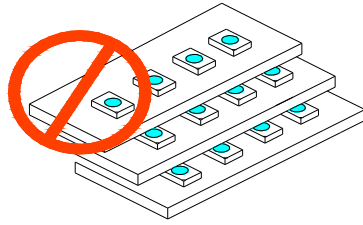

- The outer diameter of the SMD pickup nozzle should not exceed the size of the LED to prevent air leaks. The inner diameter of the nozzle should be as big as possible. A pliable material is suggested for the nozzle tip to avoid scratching or damaging the LED surface during pick up. The dimensions of the component must be accurately programmed in the pick-and-place machine to insure precise pickup and avoid damage during production.

• SMD吸嘴的外径不应超过LED的尺寸以避免漏气。吸嘴的内径应尽可能大。吸嘴头建议使用柔软的材料以避免LED硅胶表面划伤或损坏。元件的尺寸必须在贴片机器上精确地程序化，以确保准确地拾取及避免生产中的损坏。

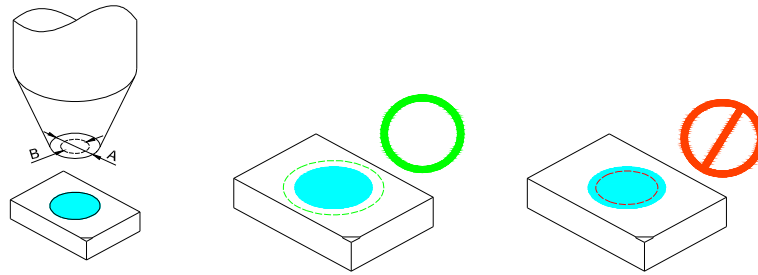

◆ **Revision History:修改记录**

Rev. No.	Change description	Date	Prepared by	Checked by
A/0	New-made specification	2022/08/20	刘鹏	余玉明